

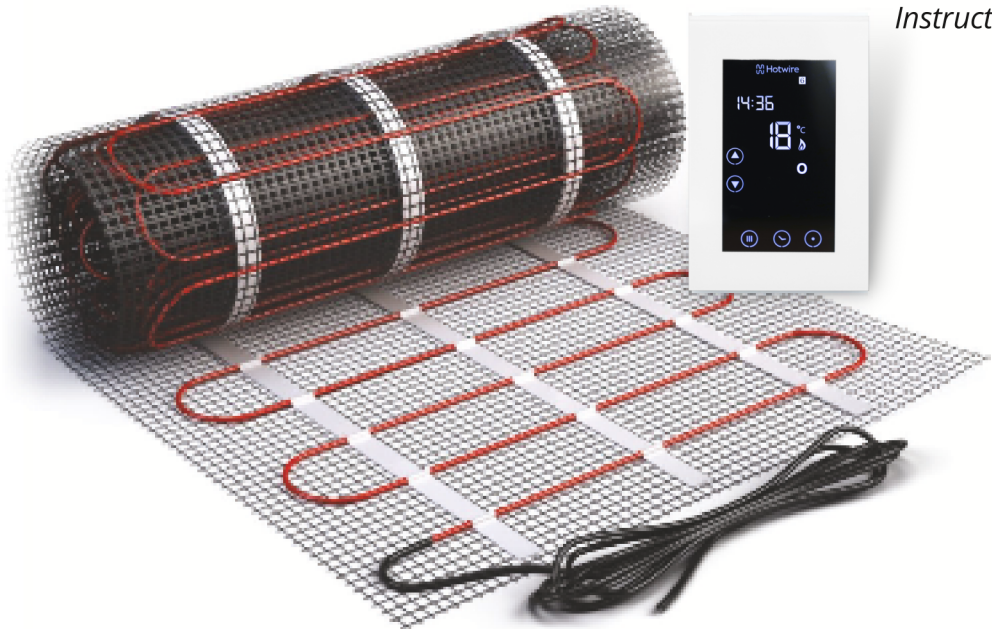

Hotwire Under Tile Heating Mat Installation Manual

Included In Each Package:

*Under Tile Heating Mat
Touch Screen Thermostat
Continuity Tester (Alarm)
Adhesive Tape
Instructions*



Contents

General	Page 3
Floor Preparation	Page 3
Marking the floor for mat installation	Page 3
Prior to the Installation of the element	Page 4
Installation of the element	Page 5
Floor probe (Sensor) & Cold Tails	Page 6
Do's and Don'ts	Page 7
Tiling Instructions	Page 8
Avoid the following	Page 8
Customer Warranty	Page 9

This product is Under Tile Heating and not In Screed Heating.

If you are looking to install a screed over the element you will need to contact your place of purchase to exchange this product.

You can lay a thin self leveller over the element if required but it should not exceed 5 mm in height.

Please read the instructions prior to your installation: The incorrect installation of the heating element may lead to damage and would invalidate your warranty

GENERAL:

1. The heating mat must only be installed as per the Hotwire instructions.
2. The heating mat **MUST NOT** be cut or shortened or the cold tail join be put under any strain
3. In accordance with the local electricity laws an authorised electrician must carry out all prescribed electrical work.
4. Your Hotwire element is classified as an electrical appliance. All electrical connections including the connection of the thermostat must be undertaken by a licensed electrician.
5. **IMPORTANT:** A certificate of Compliance (COC) must be issued by the electrician once the installation has been completed. Your electrician may need to check and test the mat installation prior to any floor covering being laid including the screed.
6. The design wattage for Hotwire mats is 150 watts per m².
7. The mat width is 450mm wire to wire.
8. Subfloor: It is essential that the subfloor is sufficiently rigid to support the heating elements and not allow unnecessary movement.

FLOOR PREPARATION:

1. Floors must be entirely clean, dry and level. If necessary sand or grind the floor first. Clean working surfaces will provide

good adhesion.

2. If a timber subfloor is being used, then we recommend tile and Slate underlay being installed prior to the elements to give the floor the rigidity required. This is especially important if the subfloor is tongue and groove flooring.
3. Water proofing membrane requirements are determined on installation methods and are subject to local council requirements/regulations.
4. Where there is no water proofing, the floor must be painted with primer and allowed to dry for 30-40 minutes. This will ensure good adhesion for taping down the element.



MARKING THE FLOOR FOR MAT INSTALLATION:

1. Mark the floor with a marker pen or crayon to show the exact area to be heated. Be sure not to lay elements in areas that may have floor fixtures installed after tiling (vanities, showers, toilets, and doorstops etc) The minimum spacing between 2 runs of the mat is 50mm and the maximum should be no more than 80mm to achieve efficient heat distribution.

2. Calculate the exact “net m2 heating area” based on your floor plan Eg: 4m² = 600 watt heating mat. When measuring the net floor area, measure off the walls, benches and shower trays the distance you require.

PRIOR TO THE INSTALLATION OF THE ELEMENT:

1. Before starting, use a multi-metre to check the resistance on the cable ensuring there is a circuit. Note the correct ohms reading (-5 + 10%) which is labelled on each cable outer packaging.

2. Prior to starting your installation, a flush box needs to be prepared for your thermostat. Then chisel or cut out 2 short channels in the subfloor at 50mm spacing. These channels are to accommodate the black joins of the cold tail, and the temperature sensor from the thermostat. This will minimise their height and create a flat surface for tiling.

Note:

The Thermostat that comes with the Kit is vertically mounted. The heating element must be protected by an RCD with a rated residual operating current not exceeding 30mA. An electrician must either install a dedicated RCD or use an existing one.

3. Plan your laying path in advance, starting directly below your flush-box position.
4. You can lay the mat in any configuration you want as long as the spacing is even over the total area to be heated. See examples below.

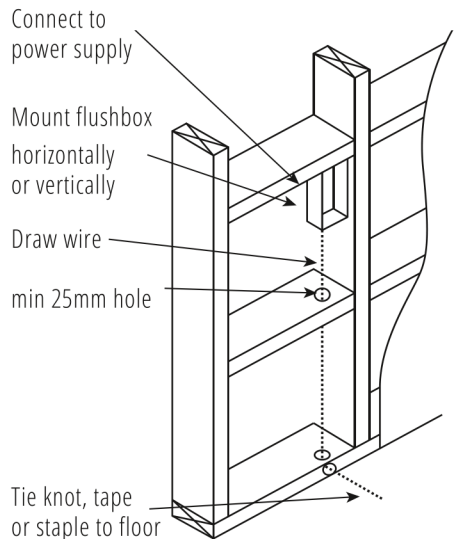
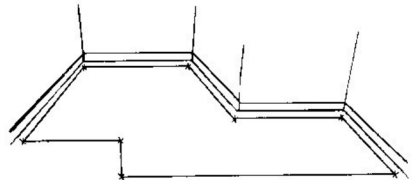

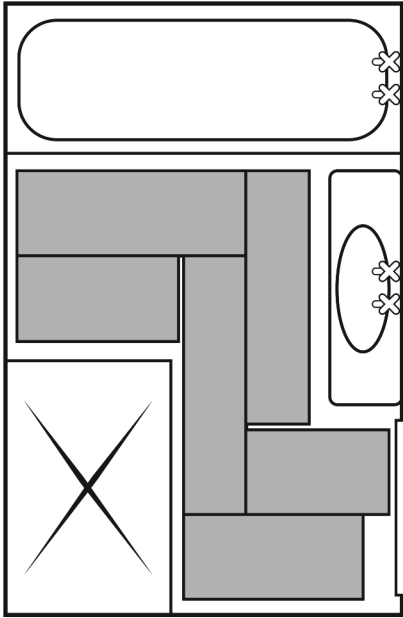

START

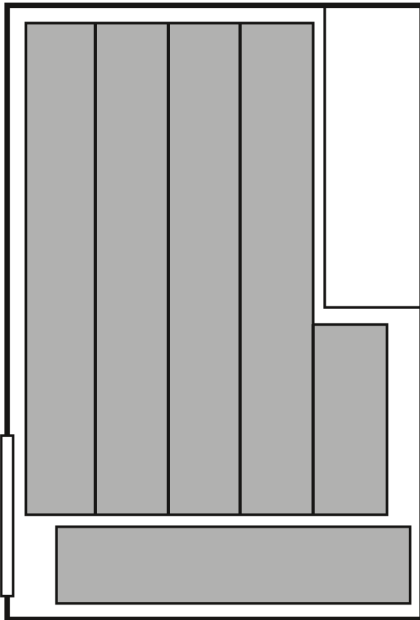

START

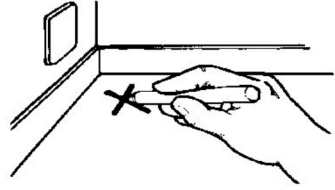

INSTALLATION OF THE ELEMENT:

1. Secure the heating element using a hot glue gun or tape. Make sure no part of the element lifts from the floor surface. This will ensure no damage occurs while screeding or tiling. The use of a spray adhesive along the areas where the cable loops acts as a primer for the tape which will also ensure no lifting occurs.

2. Once you are about 50% through the installation of the heating mat, it is recommended to unroll the remainder of it to ensure you are on target with your initial laying calculations.

3. The mat must be turned when reaching an end wall. To do this cut the tape / mesh from the mat nearest the wall, and turn the mat and place parallel to the existing lane. (Ensure even spacing between lanes is maintained.)

Note:

If you have excess element remaining, you may go back and uplift a percentage of the mat, cut the tapes / mesh then free spool the extra element out across the floor. Never cut the cable (shorten) and remember that the spacings should be kept as even as possible.

Test the element again to ensure correct ohms reading after installation and prior to any screed being laid.

FLOOR PROBE (SENSOR) & COLD TAILS:

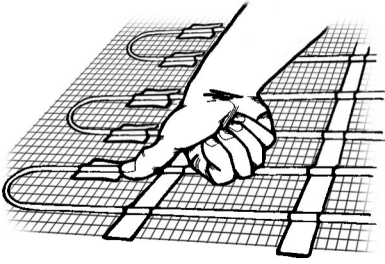

1. Recess the probe flat onto the floor approximately 50mm from the heating element. This is to ensure that it obtains the correct temperature readings. Use hot glue to hold it in place.

1

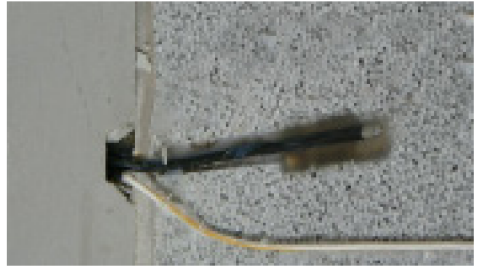
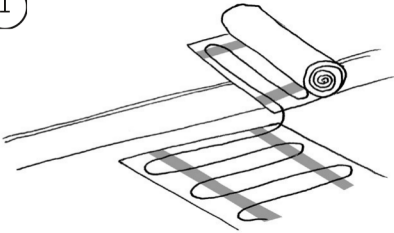

2. The probe wire must NOT cross over the heating element.

2

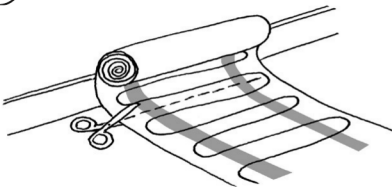

3. Ensure that there is enough probe wire to go up to the controller with the cold tail.

4. Attach a draw wire to the ends of both cold tail as well as the floor probe wire.

5. Gently pull up inside the wall so that the cold tail and probe wire can reach the flush box.

6. NEVER allow the heating element to be within the wall cavity.

7. Tape the cold tail to the flush box to avoid them dropping back down inside the wall.

8. Attach the continuity tester included in the kit to the cold tail of the element as per the instructions. This will ensure that any subsequent work on the floor will be

3

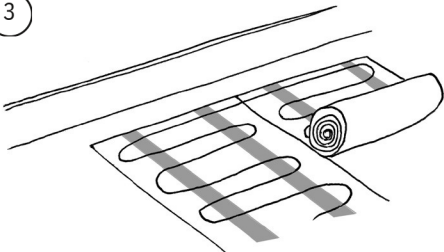

monitored for damage.

9. Prior to tiling AVOID ANY UNNECESSARY foot traffic on the element. If the floor is not being tiled /screeded immediately, a sheet of cardboard should be laid over the element as an interim measure.

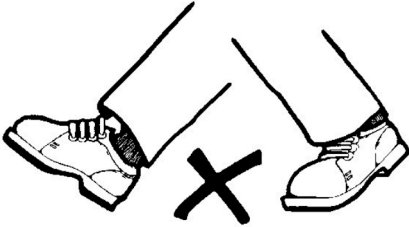

DO'S AND DON'TS:

DO's

1. Read the installation instructions prior to the installation.
2. Ensure the surface is clean and clear of obstructions
3. Plan the heat mat layout prior to installation.
4. Pre-plan post drilling Eg: doorstops vanities etc to eliminate damage to the element.
5. Before starting and after laying use a multi-metre to check the resistance on the cable ensuring there is a circuit.
6. Ensure that all heating element is positioned on the floor and not up into the wall cavity.

7. Protect the element prior to tiling

8. Check the element again for resistance readings prior to tiling starting and when tiling be very careful not to damage the element.

9. Use Tile adhesives and grouts that are suitable for use with underfloor heating.

10. Ensure that each tile is solidly bedded in adhesive with no air gaps.

11. If you are unsure of any aspect of the installation or the suitability of the subfloor to be heated, check with your supplier (place of purchase) or call 0800 HEATING for technical advice.

Don'ts

1. Don't cut or attempt to shorten the element
2. Don't commence installation on concrete floors that are not fully cured
3. Don't allow the heating element to cross over or touch – nor cross over into another room.
4. Don't allow the element to be installed on irregular surfaces.
5. Don't commence tiling before checking the continuity tester is working and that it is fitted to the elements cold tails.
6. Don't turn on the heating until the adhesives has fully cured (7 days)

ELECTRICAL SPECIFICATIONS OF HEATING MATS:

m2	Watts	Ohms	Amps
2	300	176.33	1.30
2.5	375	141.07	1.63
3	450	117.56	1.96
3.5	525	100.76	2.28
4	600	88.17	2.61
5	750	70.53	3.26
6	900	58.78	3.91
7	1050	50.38	4.57
8	1200	44.08	5.22
9	1350	39.19	5.87
10	1500	35.27	6.52

TILING INSTRUCTIONS:

1. Always use a flexible adhesive.
2. We recommend the use of a notched trowel and if possible a plastic trowel.
3. To eliminate the risk of damage to the heating cables, you may choose to apply a self levelling compound (screed) Ensure that levelling compounds are used as per the manufacturers instructions. (In particular for non-concrete floors)
4. A cement based grout should be used with no less than 10% latex content. (Latex modified acrylic, PVA, SBR)
5. Always move your trowel in the same direction as the heating elements
6. Use sufficient adhesive to eliminate voids or hollows under the tile.
7. Be careful when removing excess adhesive when scraping between tiles.

AVOID THE FOLLOWING:

1. Cutting tiles over the heating elements
2. Dropping tools or sharp objects onto the elements
3. Don't wear hard soled shoes.
4. When lifting misplaced tiles ensure that you DO NOT lift the heating cable.

CUSTOMER WARRANTY AGAINST DEFECTS FOR HOTWIRE UNDER TILE HEATING PRODUCTS

Turnkey International Pty Ltd (ABN 36 086 830 766) trading as Hotwire Heating (Hotwire)

This document contains the Warranty against defects for goods (Goods) supplied by or on behalf of Hotwire to the customer, whether an individual or company, (Customer), who purchased the Goods through an authorised distributor of Hotwire.

1)General:

a)Hotwire's Goods come with guarantees that cannot be excluded under the Australian Consumer Law as set out in Schedule 2 of the Competition and Consumer Act 2010 (Cth). The Customer is entitled to a replacement or refund for a major failure and compensation for any other reasonably foreseeable loss or damage. The Customer is also entitled to have the goods repaired or replaced if the goods fail to be of acceptable quality and the failure does not amount to a major failure. What constitutes a major failure is set out in the Australian Consumer Law.

b)The benefits under this Warranty are in addition to the Customer's other rights and remedies under the Australian Consumer Law. If the Customer is not a "consumer" or the Goods are not "of a kind ordinarily acquired for personal, domestic or household

use or consumption" for the purposes of the Australian Consumer Law, then to the extent permitted by law, Hotwire will not be liable for any direct or indirect or consequential loss in relation to any product defects.

c)Nothing in this Warranty is intended to exclude or attempt to restrict or modify the operation of the Australian Consumer Law or any other applicable law that cannot be excluded, restricted or modified by agreement. For the avoidance of doubt, Hotwire's liability in connection with the Goods is limited and excluded except to the extent that the limitation and exclusion is not permitted under the Australian Consumer Law and as set out in this Warranty.

2)Installation Manual:

a)The Hotwire installation manual (Installation Manual) is provided for the benefit of the Customer. The Goods and installation of the Goods ordinarily requires the technical skills of a qualified installer. Do not take any steps to install the Goods without a copy of the Installation Manual.

3)Installation:

a)Hotwire recommends that the Goods be installed by a registered Hotwire Installer (Authorised Installer).

b)Any installation by a person who is not an Authorised Installer must be carried out strictly in accordance with the Installation Manual taking into account the individual circumstances of the place of installation and a failure to do so may void or exclude the Customer's ability to claim under the Warranty.

4)Warranty:

a)Subject to clause 7(b), Hotwire undertakes to repair or at its sole discretion to replace any part of the Goods manufactured by Hot-wire which is found to have a manufacturing defect for a period of ten (10) years from the date of purchase.

b)The period of the Warranty described at clause 7(a) does not apply to the part of the Goods comprising (or being) the thermostat and the controller. The Warranty period in relation to the thermostat and the controller of the Goods is limited to two (2) years.

5)Exclusion and Limitation of Liability:

a)Hotwire excludes all conditions and warranties implied by custom, the general law or statute, except for:

i)Any implied condition or warranty the exclusion of which would contravene any statute or cause any part of this clause to be void; and

ii)The Warranty.

b)The Warranty does not apply if:

i)Unauthorised repairs or alterations are made to the Goods;

ii)The Customer fails to comply with all instructions of Hotwire (whether written or verbal) in relation to the fitting, installation and use of the Goods;

iii)The Goods are subjected to improper voltage or power surges, misused, damaged by accident, force of nature or any other acts beyond Hotwire's reasonable control; and/or

iv)The Goods are improperly installed or in-

stalled other than strictly in accordance with the Installation Manual (other than where such improper or other installation is carried out by an Authorised Installer).

c)The Warranty does not include calls to replace batteries, programme or re-programme thermostats and/or controllers, replace fuses or reset residual current devices or circuit breakers.

d)The total maximum liability of Hotwire under the Warranty is limited to replacing the Goods, repairing the Goods or payment of the replacement cost of the Goods.

e)Except as otherwise expressly provided in this Warranty, Hotwire will not be liable for any incidental expenses (including costs of inspection, testing, removal, reinstallation, storage or transportation), any other charges, costs or expenses of the Customer or any third party, personal injury, incidental damages, consequential losses, loss of profit, costs of business interruption, loss of opportunities or any like claims whatsoever arising from any use of, or incidental to, the Goods or their failure to operate, or arising out of Hotwire's negligence or breach of the Warranty.

f)If any component part of the Goods is manufactured by a third party or supplied to Hotwire by a third party, any warranty offered by Hotwire in relation to the Goods or a component part of the Goods will be limited to Hotwire's right of redress (if any) against the manufacturer or supplier of the component part of the Goods.

g)The Customer must keep Hotwire indemnified against:

i)All claims, expenses and liabilities of whatever nature including but not limited to loss of

profit, which may be made against or which Hotwire may sustain, pay or incur arising out of the manufacture or sale of the Goods to the Customer, except in so far as the same arises from Hotwire's negligence or breach of the Warranty or a proper claim under the Warranty; and

ii) Hotwire's costs in attending to a Warranty call by a Customer which is without merit, excluded by this clause or where no Warranty is otherwise available to the Customer together with Hotwire's costs of defending any such claim by a Customer against Hotwire (including legal costs incurred by Hotwire).

To claim on this Warranty contact:

Turnkey International Pty Ltd

(ABN 36 086 830 766) trading as
HotwireHeating

Factory 1 / 7-9 Newcastle Rd
Bayswater Vic 3153

Telephone: 1300 HOTWIRE
Email: info@hotwireheating.com.au

1300 468 947
hotwireheating.com.au